

## FLÉA

DESIGNED BY ÉMILIE CATHELINÉAU

Collection inspirée par le célèbre artiste de jazz, les suspensions *et* appliques *Fléa* jouent des effets de lumières avec le verre et le laiton. Modulables, créez vos compositions de « trompettes » à l'envi.





A collection inspired by the iconic jazz artist, the *Fléa* pendants and wall lights play with lighting effects on the glass and the brass. Adjustable, you can arrange the “trumpets” as you wish.



Applique – Wall light Fléa SB

© Philippe Charlot

<b>Finitions</b> <b>Finishes</b>	 Laiton satiné	 Graphite satiné	 Nickel satiné	 Cuivre satiné
	SB Satin brass	SG Satin graphite	SN Satin nickel	SC Satin copper

<b>Câble</b> <b>Cable</b>	 Tissu noir Black textile	 Tissu or Gold textile	<i>La longueur standard des câbles est de 2 mètres pour les suspensions et 15 cm pour les appliques mais elle peut être diminuée à l'installation. Autres longueurs sur demande.</i> <i>The standard height of the cables is 2 meters (79") for a pendant and 150 mm (5,9") for a wall light. It can be adjusted to to less during installation. Custom heights available upon request.</i>
------------------------------	---	--	--

<b>Matériaux</b> <b>Material</b>	Laiton massif Solid Brass	Verre pressé Pressed clear glass	Câble textile Textile cable
-------------------------------------	------------------------------	-------------------------------------	--------------------------------

<b>Source</b> <b>Lamping</b>	G9 LED 5W max. non fournie G9 LED 5W max. not included	Not available for 110V	Variation* Dimming*
---------------------------------	---	------------------------	------------------------

<b>Designer</b>	Émilie Cathelineau
-----------------	--------------------

\* Les luminaires variables nécessitent l'utilisation d'ampoules compatibles avec la variation  
All dimmable light fixture require the use of compatible bulbs

### Applique – Wall light

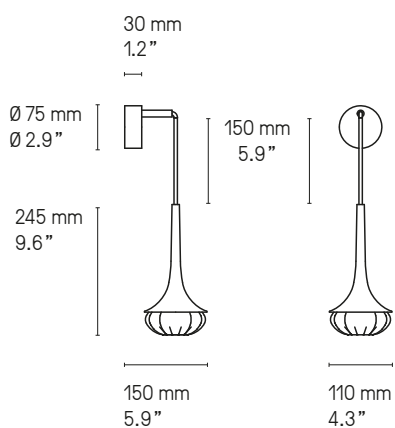

Applique – Wall light Fléa SB



Applique – Wall light Fléa SB

© Philippe Charlot

## Suspension – Pendant

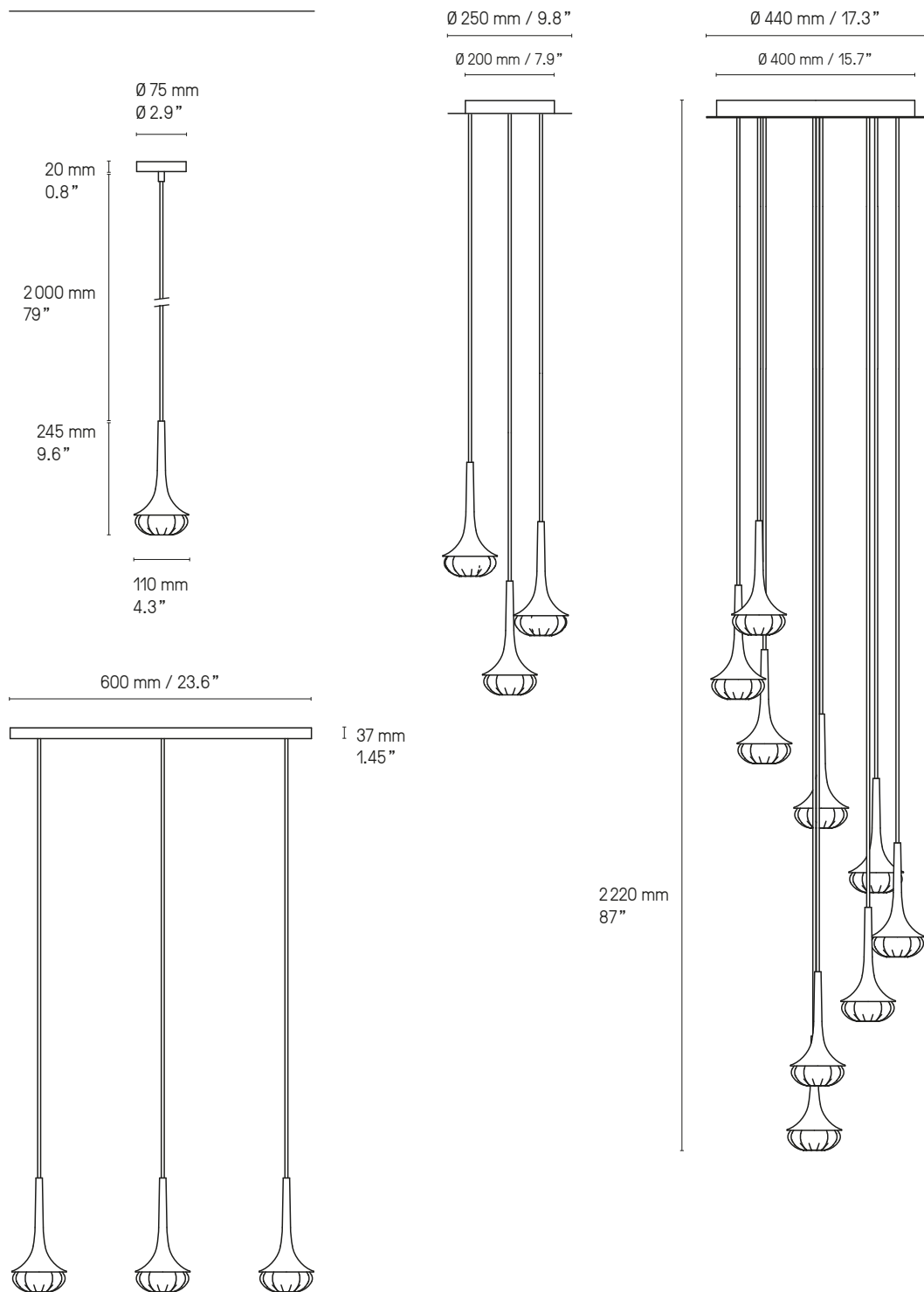

Il est possible de rassembler plusieurs suspensions sur un seul pavillon, circulaire ou rectangulaire. La version rectangulaire peut être adaptée à n'importe quelle longueur. La version circulaire a un diamètre maximum indiqué sur les croquis ci-dessus. Pour plus de renseignements, veuillez nous contacter.

It is possible to cluster several pendants from one single canopy, either rectangular or circular. The rectangular canopy can be custom-made into any size to suit your requirements. As for the circular canopy, available sizes are illustrated above. Please contact us for further information.

## NUANCIER - FINISH OPTIONS



### LAITON - BRASS

- |                                     |   |
|-------------------------------------|---|
| ① Laiton satiné<br>SB Satin brass   | ② Graphite satiné<br>SG Satin graphite  |
| ③ Nickel satiné<br>SN Satin nickel  | ④ Cuivre satiné<br>SC Satin copper      |
| ⑤ Laiton poli<br>PB Polished brass  | ⑥ Graphite poli<br>PG Polished graphite |
| ⑦ Nickel poli<br>PN Polished nickel | ⑧ Cuivre poli<br>PC Polished copper     |

### ABAT-JOURS - LAMPSHADES

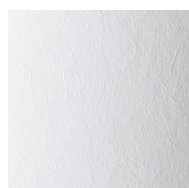

Drop Paper® 100



Drop Paper® 101

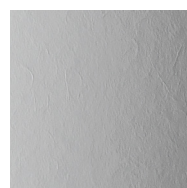

Drop Paper® 103

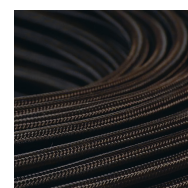

Tissu noir  
Black textile



Chinette blanche  
White chinette

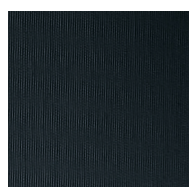

Chinette noire  
Black chinette

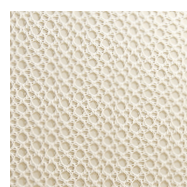

Duke  
Duke



Tissu or  
Gold textile

### VERRERIE - GLASS



Opale  
Opal

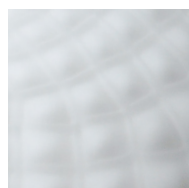

Opale et écaille  
Opal and patterned



Claire et écaille  
Clear and patterned



© Yannick Labrousse

## CVL LUMINAIRES

79 ROUTE DE LA CHEVALLERIE – 49770 LONGUENÉE-EN-ANJOU – FRANCE

TEL. +33 (0) 2 41 32 67 54

EMAIL : CONTACT@CVL-LUMINAIRES.FR

**WWW.CVL-LUMINAIRES.FR**

Brand identity & art direction: [POOL](#) Layout & production supervision: [deuxpointdeux](#)  
Texts: [Valérie Marion](#) Translation: [CVL](#) Photos: [Garnier Studios](#) except when mentioned otherwise 3D: [CVL](#) except when mentioned otherwise

Make sure to download our latest catalogue [here](#)